

# Panasonic®

## Operating Instructions

---

### Cordless Telephone

Model No. **KX-TGC350**  
**KX-TGC352**

### Cordless Telephone with Digital Answering Machine

Model No. **KX-TGC360**  
**KX-TGC362**  
**KX-TGC364**  
**KX-TG3620**



Model shown is KX-TGC350.

***Before initial use, see “Getting Started”  
on page 8.***

**Thank you for purchasing a Panasonic product.**

Please read these operating instructions before using the unit and save them for future reference.

**Consulte “Guía Rápida Española”, página 36.**

For assistance, visit our Web site: <http://shop.panasonic.com/support> for customers in the U.S.A.

**Please register your product: <http://shop.panasonic.com/support>**

## Table of Contents

<b>Introduction</b>		
Model composition .....	3	
Accessory information .....	3	
Graphical symbols for use on equipment and their descriptions .....	4	
<b>Important Information</b>		
For your safety .....	5	
Important safety instructions .....	6	
For best performance .....	6	
Other information .....	7	
Specifications .....	7	
<b>Getting Started</b>		
Setting up .....	8	
Controls .....	9	
Display icons .....	10	
Language settings .....	10	
Date and time .....	10	
Recording your greeting message (KX-TGC360 series) .....	11	
Other settings .....	11	
<b>Making/Answering Calls</b>		
Making calls .....	12	
Answering calls .....	12	
Useful features during a call .....	12	
Intercom .....	13	
<b>Phonebook</b>		
Phonebook .....	14	
Speed dial .....	15	
<b>Programming</b>		
Menu list .....	17	
Alarm .....	20	
Silent mode .....	20	
Call block .....	20	
Other programming .....	21	
Registering a handset to the base unit .....	22	
<b>Caller ID Service</b>		
Using Caller ID service .....	23	
Caller list .....	23	
<b>Answering System</b>		
Answering system (KX-TGC360 series) .....	24	
Turning the answering system on/off .....	24	
Greeting message .....	24	
Listening to messages .....	24	
Remote operation .....	25	
Answering system settings .....	26	
<b>Useful Information</b>		
Voicemail service .....	28	
Error messages .....	29	
Troubleshooting .....	29	
Wall mounting (Charger only) .....	32	
FCC and other information .....	33	
<b>Guía Rápida Española</b>		
Guía Rápida Española .....	36	
<b>Appendix</b>		
Customer services .....	40	
Limited Warranty (ONLY FOR U.S.A.) .....	41	
<b>Index</b>		
Index .....	43	

## Model composition

Series	Model No.	Base unit	Handset	
		Part No.	Part No.	Quantity
KX-TGC350 series	KX-TGC350	KX-TGC350	KX-TGCA35	1
	KX-TGC352	KX-TGC350	KX-TGCA35	2
KX-TGC360 series	KX-TGC360	KX-TGC360	KX-TGCA35	1
	KX-TGC362	KX-TGC360	KX-TGCA35	2
	KX-TGC364	KX-TGC360	KX-TGCA35	4
	KX-TG3620	KX-TGC360	KX-TGCA35	1

## Accessory information

### Supplied accessories

No.	Accessory item/Part number	Quantity		
		KX-TGC350 KX-TGC360 KX-TG3620	KX-TGC352 KX-TGC362	KX-TGC364
①	AC adaptor/PNLV226-0X	1	1	1
②	Telephone line cord/ PQJA10075Y (Black) or PQJA10075Z (Transparence)	1	1	1
③	Rechargeable batteries/HHR-4DPA	2	4	8
④	Handset cover*1/PNYNTGCA35BR	1	2	4
⑤	Charger/PNLC1073ZB	–	1	3

\*1 The handset cover comes attached to the handset.



### Additional/replacement accessories

Please contact your nearest Panasonic dealer for sales information (page 40).

## Introduction













Accessory item	Model number/Specifications
Rechargeable batteries	HHR-4DPA <ul style="list-style-type: none"> <li>To order, please visit <a href="http://shop.panasonic.com/support">http://shop.panasonic.com/support</a></li> </ul>
	Battery type: <ul style="list-style-type: none"> <li>Nickel metal hydride (Ni-MH)</li> <li>2 x AAA (R03) size for each handset</li> </ul>
Range extender*1	KX-TGA405, KX-TGA407

\*1 By installing this unit, you can extend the range of your phone system to include areas where reception was previously not available. This product can be purchased online. Please visit our Web site: <http://shop.panasonic.com/support>

## Expanding your phone system

Handset (optional): KX-TGDA20
You can expand your phone system by registering optional handsets (6 max.) to a single base unit.

## Graphical symbols for use on equipment and their descriptions

Symbol	Explanation	Symbol	Explanation
	Alternating current (A.C.)		Class II equipment (equipment in which protection against electric shock relies on Double Insulation or Reinforced Insulation)
	Direct current (D.C.)		"ON" (power)
	Protective earth		"OFF" (power)
	Protective bonding earth		Stand-by (power)
	Functional earth		"ON"/"OFF" (power; push-push)
	For indoor use only		Caution, risk of electric shock

## Important Information

### For your safety

To prevent severe injury and loss of life/property, read this section carefully before using the product to ensure proper and safe operation of your product.

#### WARNING

##### Power connection

- Use only the power source marked on the product.
- Do not overload power outlets and extension cords. This can result in the risk of fire or electric shock.
- Completely insert the AC adaptor/power plug into the power outlet. Failure to do so may cause electric shock and/or excessive heat resulting in a fire.
- Regularly remove any dust, etc. from the AC adaptor/power plug by pulling it from the power outlet, then wiping with a dry cloth. Accumulated dust may cause an insulation defect from moisture, etc. resulting in a fire.
- Unplug the product from power outlets if it emits smoke, an abnormal smell, or makes an unusual noise. These conditions can cause fire or electric shock. Confirm that smoke has stopped emitting and contact us at <http://shop.panasonic.com/support>
- Unplug from power outlets and never touch the inside of the product if its casing has been broken open.
- Never touch the plug with wet hands. Danger of electric shock exists.

##### Installation

- To prevent the risk of fire or electrical shock, do not expose the product to rain or any type of moisture.
- Do not place or use this product near automatically controlled devices such as automatic doors and fire alarms. Radio waves emitted from this product may cause such devices to malfunction resulting in an accident.

- Do not allow the AC adaptor or telephone line cord to be excessively pulled, bent or placed under heavy objects.

##### Operating safeguards

- Unplug the product from power outlets before cleaning. Do not use liquid or aerosol cleaners.
- Do not disassemble the product.
- Do not spill liquids (detergents, cleansers, etc.) onto the telephone line cord plug, or allow it to become wet at all. This may cause a fire. If the telephone line cord plug becomes wet, immediately pull it from the telephone wall jack, and do not use.

##### Medical

- Consult the manufacturer of any personal medical devices, such as pacemakers or hearing aids, to determine if they are adequately shielded from external RF (radio frequency) energy. (The product operates in the frequency range of 1.92 GHz to 1.93 GHz, and the RF transmission power is 115 mW (max.).)
- Do not use the product in health care facilities if any regulations posted in the area instruct you not to do so. Hospitals or health care facilities may be using equipment that could be sensitive to external RF energy.

#### CAUTION

##### Installation and location

- Never install telephone wiring during an electrical storm.
- Never install telephone line jacks in wet locations unless the jack is specifically designed for wet locations.
- Never touch uninsulated telephone wires or terminals unless the telephone line has been disconnected at the network interface.
- Use caution when installing or modifying telephone lines.
- The AC adaptor is used as the main disconnect device. Ensure that the AC outlet is installed near the product and is easily accessible.

For assistance, please visit <http://shop.panasonic.com/support>

5

## Important Information

- This product is unable to make calls when:
  - the handset batteries need recharging or have failed.
  - there is a power failure.

### Battery

- We recommend using the batteries noted on page 4. **USE ONLY rechargeable Ni-MH batteries AAA (R03) size.**
- Do not mix old and new batteries.
- Do not open or mutilate the batteries. Released electrolyte from the batteries is corrosive and may cause burns or injury to the eyes or skin. The electrolyte is toxic and may be harmful if swallowed.
- Exercise care when handling the batteries. Do not allow conductive materials such as rings, bracelets, or keys to touch the batteries, otherwise a short circuit may cause the batteries and/or the conductive material to overheat and cause burns.
- Charge the batteries provided with or identified for use with this product only, in accordance with the instructions and limitations specified in this manual.
- Only use a compatible base unit (or charger) to charge the batteries. Do not tamper with the base unit (or charger). Failure to follow these instructions may cause the batteries to swell or explode.

#### Attention:



A nickel metal hydride battery that is recyclable powers the product you have purchased.

Please call 1-800-8-BATTERY (1-800-822-8837) for information on how to recycle this battery.

## Important safety instructions

When using your product, basic safety precautions should always be followed to reduce the risk of fire, electric shock, and injury to persons, including the following:

1. Do not use this product near water for example, near a bathtub, washbowl, kitchen sink, or laundry tub, in a wet basement or near a swimming pool.
2. Avoid using a telephone (other than a cordless type) during an electrical storm. There may be a remote risk of electric shock from lightning.
3. Do not use the telephone to report a gas leak in the vicinity of the leak.
4. Use only the power cord and batteries indicated in this manual. Do not dispose of batteries in a fire. They may explode. Check with local codes for possible special disposal instructions.

### SAVE THESE INSTRUCTIONS

## For best performance

### Environment

- The product should be kept free from excessive smoke, dust, high temperature, and vibration.
- When you leave the product unused for a long period of time, unplug the product from the power outlet.
- The product should be kept away from heat sources such as heaters, kitchen stoves, etc. It should not be placed in rooms where the temperature is less than 0 °C (32 °F) or greater than 40 °C (104 °F). Damp basements should also be avoided.
- Operating the product near electrical appliances may cause interference. Move away from the electrical appliances.

## Other information

**CAUTION:** Risk of explosion if battery is replaced by an incorrect type. Dispose of used batteries according to the instructions.

### Notice for product disposal, transfer, or return

- This product can store your private/confidential information. To protect your privacy/confidentiality, we recommend that you erase information such as phonebook or caller list entries from the memory before you dispose of, transfer, or return the product.

### Notice

- This product is designed for use in the United States of America. Sale or use of this product in other countries may violate local laws.
- Cet appareil est conçu pour être utilisé aux États-Unis d'Amérique. La vente ou l'emploi de cet appareil dans certains autres pays peut constituer une infraction à la législation locale.
- Este producto está diseñado para usarse en los Estados Unidos de América. La venta o el empleo de este producto en ciertos países puede constituir violación de la legislación local.
- 本產品專為美國使用而設。若在其他國家銷售或使用，可能會違反當地法例。
- この製品は、日本国外での使用を目的として設計されており、日本国内での使用は法律違反となります。従って、当社では日本国内においては原則として修理などのサービスは致しかねます。

## Specifications

- **Standard:**  
DECT 6.0 (Digital Enhanced Cordless Telecommunications 6.0)
  - **Frequency range:**  
1.92 GHz to 1.93 GHz
  - **RF transmission power:**  
115 mW (max.)
  - **Power source:**  
120 V AC, 60 Hz
  - **Power consumption:**  
**Base unit\*1:**  
Standby: 0.6 W  
Maximum: 3.2 W  
**Base unit\*2:**  
Standby: 0.7 W  
Maximum: 3.5 W  
**Charger:**  
Standby: 0.1 W  
Maximum: 1.8 W
  - **Operating conditions:**  
0 °C – 40 °C (32 °F – 104 °F), 20 % – 80 % relative air humidity (dry)
- \*1 KX-TGC350 series  
\*2 KX-TGC360 series

## Getting Started

### Setting up

#### Connections

- 1 Connect the AC adaptor to the unit by pressing the plug firmly.
- 2 Fasten the cord by hooking it.
- 3 Connect the AC adaptor to the power outlet.
- 4 Connect the telephone line cord to the unit, then to the single-line telephone jack (RJ11C) until you hear a click.
- 5 A DSL/ADSL filter (not supplied) is required if you have a DSL/ADSL service.

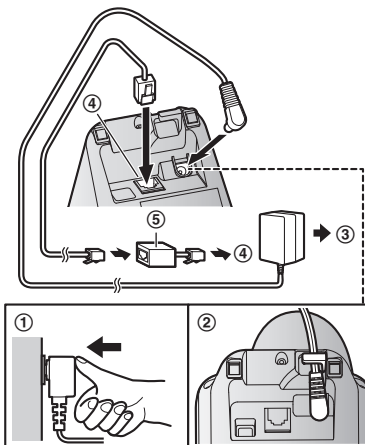

### Battery installation

- USE ONLY rechargeable Ni-MH batteries AAA (R03) size (A).
- Do NOT use alkaline/manganese/Ni-Cd batteries.
- Confirm correct polarities (+, -).

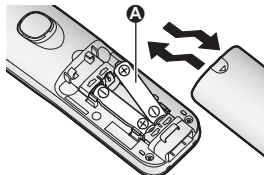

### Battery charging

Charge for about 7 hours.

#### Note for battery charging

- Clean the charge contacts with a soft and dry cloth once a month. Before cleaning the unit, disconnect from power outlets and any telephone line cords.

### Battery level

Icon	Battery level
	High
	Medium
	Low
	Needs charging.
	Empty

### Ni-MH battery performance (supplied batteries)

Operation	Operating time
In continuous use	9 hours max.*1
Not in use (standby)	4 days max.*1

\*1 If eco mode is on.



**Note:**

- Actual battery performance depends on usage and ambient environment.

## Intelligent eco mode

This feature automatically reduces handset power consumption whenever possible. When it is activate, **ECO** is displayed.

## Controls

### Handset

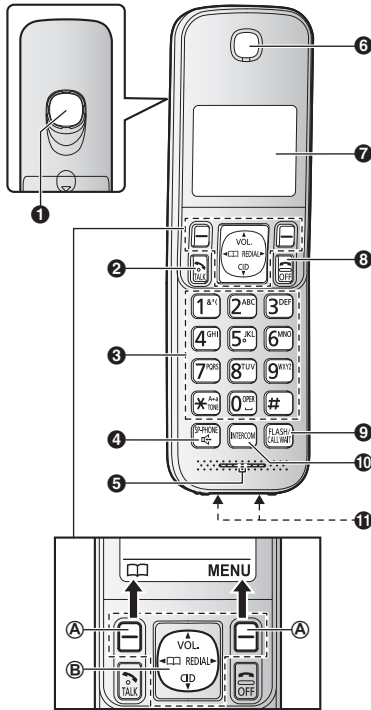

**1** Speaker

- 2** **[TALK]** (TALK)
- 3** Dial keypad (**[TONE]**)
- 4** **[SP-PHONE]** (SP-PHONE: Speakerphone)
- 5** Microphone
- 6** Receiver
- 7** Display
- 8** **[OFF]**
- 9** **[FLASH][CALL WAIT]**
- 10** **[INTERCOM]**
  - This feature is available between 2 handsets.
- 11** Charge contacts
- (A)** Soft keys
- (B)** Navigator key
  - **[▲]**, **[▼]**, **[◀]**, or **[▶]**: Scroll through various lists and items.
  - VOL. (Volume: **[▲]** or **[▼]**): Adjust the receiver or speaker volume while talking.
  - **[☐]**: View the phonebook entry.
  - **[▶]** REDIAL: View the redial list.
  - **[▼]** CID (Caller ID): View the caller list.

### Base unit

- KX-TGC350 series



- 1** Charge contacts
- 2** **[LOCATOR]** (LOCATOR)

For assistance, please visit <http://shop.panasonic.com/support>

## Getting Started

### ■ KX-TGC360 series

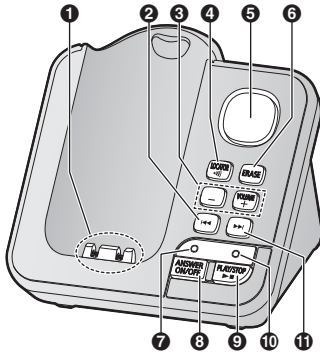

- 1 Charge contacts
- 2 [◀] (Repeat)
- 3 [⏮]/[⏭] (VOLUME: Volume up/down)
- 4 [📶] (LOCATOR)
- 5 Speaker
- 6 [ERASE]
- 7 ANSWER ON/OFF indicator
- 8 [ANSWER ON/OFF]
- 9 [▶] (PLAY/STOP)
- 10 Message indicator
- 11 [▶▶] (Skip)

## Display icons

### Handset display items

Item	Meaning
📶	Within base unit range
📶	Out of base unit range
📞	The line is in use. <ul style="list-style-type: none"> <li>• When flashing: The call is put on hold.</li> <li>• When flashing rapidly: An incoming call is now being received.</li> </ul>
ECO	Eco mode is on. (page 9)
📞	Speakerphone is on. (page 12)

Item	Meaning
🔇	Ringer volume is off. (page 12)
ZZZ	Silent mode is on. (page 20)
PRIV	Call sharing mode is off. (page 19)
🕒	Alarm is on. (page 20)
1	Handset number
🔋	Battery level
🚫	Blocked call (page 20)
BOOST	Clarity booster is on automatically.
In use	Answering system is being used by the base unit (KX-TGC360 series) or another handset.
Line in use	Someone is using the line.

## Language settings

### Display language

- 1 [MENU]#1110
- 2 [↕]: Select the desired setting. → [SAVE] → [OFF]

### Voice guidance language (KX-TGC360 series)

- 1 [MENU]#1112
- 2 [↕]: Select the desired setting. → [SAVE] → [OFF]

### Date and time

- 1 [MENU]#1011

## Getting Started

- 2 Enter the current month, date, and year by selecting 2 digits for each.  
**Example:** July 15, 2016  
[0] [7] [1] [5] [1] [6]
- 3 [OK]
- 4 Enter the current hour and minute (12-hour clock format) by selecting 2 digits for each.  
**Example:** 9:30  
[0] [9] [3] [0]
- 5 [X]: Select “AM” or “PM”.
- 6 [SAVE] → [OFF]

### Note:

- Either 12-hour or 24-hour time format is used depending on the display language.

## Recording your greeting message (KX-TGC360 series)

You can record your own greeting message instead of using a pre-recorded greeting message. See page 24 for details.

- 1 [MENU] [#] [3] [0] [2]
- 2 [↕]: “Yes” → [SELECT]
- 3 Record a greeting message. → [STOP] → [OFF]

## Other settings

### Dialing mode

- 1 [MENU] [#] [1] [2] [0]
- 2 [↕]: Select the desired setting. → [SAVE] → [OFF]

## Making/Answering Calls

### Making calls

- 1 Lift the handset and dial the phone number.
  - To correct a digit, press **[CLEAR]**.
- 2 **[↶]** or **[↷]**
  - To adjust the receiver or speaker volume, press **[▲]** or **[▼]** repeatedly.
- 3 When you finish talking, press **[OFF]**.

#### Note:

- To switch back to the receiver, press **[↷]**/**[↶]**.

### Making a call using the redial list

The last 5 phone numbers dialed are stored in the redial list.

- 1 **[▶]** REDIAL
- 2 **[↕]**: Select the desired entry. → **[↶]**

### Pause (for PBX/long distance service users)

A pause is sometimes required when making calls using a PBX or long distance service. When storing a calling card access number and/or PIN in the phonebook, a pause is also needed (page 15).

**Example:** If you need to dial the line access number "9" when making outside calls with a PBX:

- 1 **[9]** → **[▲]** (Pause)
- 2 Dial the phone number. → **[↶]**

### Answering calls

- 1 Lift the handset and press **[↶]** or **[↷]** when the unit rings.
  - 2 When you finish talking, press **[OFF]**.
- Auto talk:** You can answer calls simply by lifting the handset (page 19).
- Temporary handset ringer off:** Press **[⏏]**.

### Adjusting the handset ringer volume

Press **[▲]** or **[▼]** repeatedly while ringing.

### Adjusting the base unit ringer volume (KX-TGC360 series)

Press **[+]** or **[-]** repeatedly.

- To turn the ringer off, press and hold **[-]** until the unit beeps.

### Useful features during a call

#### Hold

- 1 Press **[MENU]** during an outside call.
- 2 **[↕]**: "Hold" → **[SELECT]**
- 3 To release hold, press **[↶]**.

#### Note:

- After holding for 10 minutes, the call is disconnected.

#### Mute

- 1 Press **[MUTE]** during a call.
- 2 To return to the call, press **[MUTE]**.

#### Flash

**[FLASH]** allows you to use the special features of your host PBX.

#### Note:

- To change the flash time, see page 19.

### For call waiting or Call Waiting Caller ID service users

To use call waiting or Call Waiting Caller ID, you must first subscribe with your phone service provider.

This feature allows you to receive calls while you are already talking on the phone. If you receive a call while on the phone, you will hear a call waiting tone.

## Making/Answering Calls

If you subscribe to both **Caller ID and Call Waiting with Caller ID services**, the 2nd caller's information is displayed on the handset that is in use after you hear the call waiting tone.

- 1 Press **[CALL WAIT]** to answer the 2nd call.
- 2 To switch between calls, press **[CALL WAIT]**.

### Note:

- Please contact your phone service provider for details and availability of this service in your area.

## Temporary tone dialing (for rotary/pulse service users)

Press **[\*]** (TONE) before entering access numbers which require tone dialing.

## Call share

While you are on an outside call, another unit can join the conversation. Only 2 units can join an outside call.

### Note:

- To prevent other users from joining your conversations, turn call sharing mode off (page 19).

## Transferring calls, conference calls

- 1 During an outside call, press **[INTERCOM]**.  
When 3 or more handsets are registered:  
**[\*]**: Select the desired unit. → **[SELECT]**
- 2 Wait for the paged party to answer.
  - If the paged party does not answer, press **[↶]** to return to the outside call.
- 3 **To complete the transfer:**  
Press **[OFF]**.  
**To establish a conference call:**  
**[MENU]** → **[\*]**: "Conf." → **[SELECT]**
  - To leave the conference, press **[OFF]**.

- To put the outside call on hold:  
**[MENU]** → **[\*]**: "Hold" → **[SELECT]**  
To resume the conference: **[MENU]** → **[\*]**: "Conf." → **[SELECT]**
- To cancel the conference: **[MENU]** → **[\*]**: "Stop conference" → **[SELECT]**

## Intercom

### Making an intercom call

- 1 **[INTERCOM]**.  
When 3 or more handsets are registered:  
**[\*]**: Select the desired unit. → **[SELECT]**

## Phonebook

### Phonebook

You can add 50 names (16 characters max.) and phone numbers (24 digits max.) to the phonebook.

#### Adding phonebook entries

- 1 or → [MENU]
- 2 : "Add new entry" → [SELECT]
- 3 Enter the party's name. → [OK]
- 4 Enter the party's phone number. → [OK]
- 5 : Select the desired group. → [SELECT] 2 times → [OFF]

#### Entering characters

Press the dial key that corresponds to the desired character. Press repeatedly to scroll through the available characters. The following operations are also available.

Key	Operation
	Switch between the uppercase and lowercase (A ↔ a)
	Move the cursor
[CLEAR]	Erase the character or number <ul style="list-style-type: none"><li>• To erase all, press and hold it.</li></ul>

#### Storing a redial list number to the phonebook

- 1 REDIAL
- 2 : Select the desired entry. → [SAVE]
- 3 To store the name, continue from step 3, "Editing entries", page 15.

#### Storing caller information to the phonebook

- 1 CID

- 2 : Select the desired entry.
  - To edit the number: [MENU] → : "Edit" → [SELECT]  
Press [EDIT] repeatedly until the phone number is shown in the desired format. And then, press [SAVE]. Go to step 5.
- 3 [MENU]
- 4 : "Save CID" → [SELECT]
- 5 : "Phonebook" → [SELECT]
- 6 Continue from step 3, "Editing entries", page 15.

### Groups

You can assign your phone entries to groups for each searching. You can assign a ringtone to each group to help identify incoming calls (Caller ID required).

#### Changing group names/setting ringer ID

- 1 or → [MENU]
- 2 : "Group" → [SELECT]
- 3 : Select the desired group. → [SELECT]
- 4 **To change group names**  
: "Group name" → [SELECT] → Edit the name. → [SAVE]  
**To set group ringer tone**  
: Select the current setting of the group ringer tone. → [SELECT] → : Select the desired ringer tone. → [SAVE]
- 5 [OFF]

#### Finding and calling from a phonebook entry

- 1 or
- 2 : Select the desired entry.
- 3

### Editing entries

- 1 Find the desired entry (page 14).
- 2 **[MENU]** → **[↕]**: "Edit" → **[SELECT]**
- 3 Edit the name if necessary. → **[OK]**
- 4 Edit the phone number if necessary. → **[OK]**
- 5 **[↕]**: Select the desired group (page 14). → **[SELECT]** 2 times → **[OFF]**

### Erasing an entry

- 1 Find the desired entry (page 14).
- 2 **[MENU]** → **[↕]**: "Erase" → **[SELECT]**
- 3 **[↕]**: "Yes" → **[SELECT]** → **[OFF]**

### Chain dial

This feature allows you to dial phone numbers in the phonebook while you are on a call. This feature can be used, for example, to dial a calling card access number or bank account PIN that you have stored in the phonebook, without having to dial manually.

- 1 During an outside call, press **[MENU]**.
- 2 **[↕]**: "Phonebook" → **[SELECT]**
- 3 **[↕]**: Select the desired entry.
- 4 Press **[CALL]** to dial the number.

#### Note:

- When storing a calling card access number and your PIN in the phonebook as one phonebook entry, press **[▲]** (Pause) to add pauses after the number and PIN as necessary (page 12).
- If you have rotary/pulse service, you need to press **[☒]** (TONE) before pressing **[MENU]** in step 1 to change the dialing mode temporarily to tone. When adding entries to the phonebook, we recommend adding **[☒]** (TONE) to the beginning of phone numbers you wish to chain dial (page 14).

### Speed dial

You can assign 1 phone number to each of the dial keys (**[1]** to **[9]**) on the handset.

### Adding phone numbers to speed dial keys

#### ■ By entering phone numbers:

- 1 Press and hold the desired speed dial key (**[1]** to **[9]**). → **[ADD]**
- 2 **[↕]**: "Manual" → **[SELECT]**
- 3 Enter the party's name. → **[OK]**
- 4 Enter the party's phone number. → **[OK]** → **[SELECT]** → **[OFF]**

#### ■ From the phonebook:

- 1 Press and hold the desired speed dial key (**[1]** to **[9]**). → **[ADD]**
- 2 **[↕]**: "Phonebook" → **[SELECT]**
- 3 **[↕]**: Select the desired entry. → **[SAVE]** → **[OFF]**

#### Note:

- If you edit a phonebook entry which is assigned to a speed dial key, the edited entry does not transfer to the speed dial key.

### Editing an entry

- 1 Press and hold the desired speed dial key (**[1]** to **[9]**). → **[MENU]**
- 2 **[↕]**: "Edit" → **[SELECT]**
- 3 Edit the name if necessary. → **[OK]**
- 4 Edit the phone number if necessary. → **[OK]** → **[SELECT]** → **[OFF]**

## Phonebook

---

### Erasing an entry

- 1 Press and hold the desired speed dial key ([1] to [9]). → [MENU]
- 2 [↵]: "Erase" → [SELECT]
- 3 [↵]: "yes" → [SELECT] → [OFF]

### Making a call

Press and hold the desired speed dial key ([1] to [9]). → [📞]



## Menu list

Scrolling through the display menus: [MENU] → Press [▼] or [▲] to select the desired main menu. → [SELECT]

OR

Using the direct command code: [MENU] → Enter the desired code.

Example: Press [MENU] [#]1[0]1.

- To exit the operation, press [OFF].

### Display menu tree and direct command code table

Main menu: ☰ “Phonebook”

Operation	Code	Page
Viewing the phonebook entry.	#280	14

Main menu: →) “Caller list”

Operation	Code	Page
Viewing the caller list.	#213	23

Main menu: ☐☐ “Answering device”<sup>\*1</sup>

Sub-menu 1	Sub-menu 2	Settings <Default>	Code	Page
Play new msg.	–	–	#323	25
Play all msg.	–	–	#324	25
Erase all msg.	–	–	#325	–
Greeting	Record greeting	–	#302	24
	Check greeting	–	#303	24
	Pre-recorded	–	#304	24
Settings	Ring count	Toll saver <4 rings> 2-7 rings	#211	26
	Recording time	<3 min> 1 min Greeting only <sup>*2</sup>	#305	27
	Remote code	<111>	#306	25
	Screen call	<On> Off	#310	26
Answer on	–	–	#327	–
Answer off	–	–	#328	–

## Programming

Main menu: ☒ “V.M. access” (V.M.: Voicemail)

Operation	Code	Page
Listening to voicemail messages.	#330	28

Main menu: 📞 “Intercom”

Operation	Code	Page
Paging the desired unit.	#274	13

Main menu: ⌚ “Set date & time”

Sub-menu 1	Sub-menu 2	Settings <Default>	Code	Page
Date and time	–	–	#101	10
Alarm	–	<Off> Once Daily	#720	20
Time adjustment* <sup>3</sup>	–	<Caller ID auto> Manual	#226	–

Main menu: 🗨 “Initial setting”

Sub-menu 1	Sub-menu 2	Settings <Default>	Code	Page
Ringer setting	Ringer volume	Off-6 <6>	#160	12
	Ringer tone* <sup>4</sup>	<Tone 1>	#161	–
	Silent mode – On/Off	On <Off>	#238	20
	Silent mode – Start/End	<11:00 PM/06:00 AM>	#237	20
Set date & time	Date and time	–	#101	10
	Alarm	<Off> Once Daily	#720	20
	Time adjustment* <sup>3</sup>	<Caller ID auto> Manual	#226	–
Handset name	–	–	#104	21
Call block	–	–	#217	20
	First ring	<On> Off	#173	21
	Block w/o num* <sup>2</sup>	On <Off>	#240	21
Speed dial	–	–	#261	15

## Programming

Sub-menu 1	Sub-menu 2	Settings <Default>	Code	Page
Voice mail	Store VM access#	–	#331	28
	VM tone detect	<On> Off	#332	28
LCD contrast	–	Level 1–4 <2>	#145	–
Key tone	–	<On> Off	#165	–
Caller ID edit	–	<On> Off	#214	23
Auto talk	–	On <Off>	#200	12
Set tel line	Set dial mode	<Tone> Pulse	#120	11
	Set flash time	80 ms 90 ms 100 ms 110 ms 160 ms 200 ms 250 ms 300 ms 400 ms 600 ms <700 ms> 900 ms	#121	12
	Set line mode*5	A <B>	#122	–
Call sharing	–	<On> Off	#194	13
Registration	Register handset	–	#130	22
	Deregistration*2	–	#131	22
Change language	Display	<English> Español	#110	10
	Voice prompt*1	<English> Español	#112	10

Main menu: ? “Customer support”

Operation	Code	Page
Displaying customer support Web address.	#680	–

\*1 KX-TGC360 series

\*2 This menu is not displayed when scrolling through the display menus. It is only available in direct command code.

## Programming

- \*3 This feature allows the unit to automatically adjust the date and time each time caller information including date and time is received.  
To turn this feature on, select “**Caller ID auto**”. To turn this feature off, select “**Manual**”. (Caller ID subscribers only)  
To use this feature, set the date and time first (page 10).
- \*4 The preset melodies in this product (“**Tone 3**” - “**Tone 5**”, “**Melody 1**” - “**Melody 10**”) are used with permission of © 2012 Copyrights Vision Inc.
- \*5 Generally, the line mode setting should not be changed. This setting automatically maintains receiver volume at the proper level depending on the current telephone line condition. Set the line mode to “**A**” if telephone line condition is not good.

### Alarm

An alarm sounds at the set time for 3 minutes once or daily. Alarm can be set for each handset.

- 1 **[MENU][#][7][2][0]**
- 2 **[↕]**: Select the desired alarm option. → **[SELECT]**
- 3 Enter the desired month and date. → **[OK]**
- 4 Set the desired time.
- 5 **[⊗]**: Select “**AM**” or “**PM**”. → **[OK]**
- 6 **[↕]**: Select the desired alarm tone. → **[SELECT]**
- 7 **[SELECT]** → **[OFF]**

### Silent mode

Silent mode allows you to select a period of time during which the handset will not ring for outside calls. This feature is useful for time periods when you do not want to be disturbed, for example, while sleeping. Silent mode can be set for each unit.

#### Important:

- If you have set the alarm, the alarm sounds even if the silent mode is turned on.

### Turning silent mode on/off

- 1 **[MENU][#][2][3][8]**

- 2 **[↕]**: Select the desired setting. → **[SAVE]**
- 3 Follow the directions on the display to complete the operation.

### Changing the start and end time

- 1 **[MENU][#][2][3][7]**
- 2 Follow the directions on the display to complete the operation.

### Call block

This feature allows the unit to block calls when:

- the unit receives a call from a phone number stored in the call block list as unwanted (“Storing unwanted callers”, page 21).
- the unit receives a call without phone number (“Blocking incoming calls that have no phone number”, page 21).

When a call is received, the unit rings once\*1 while caller information is being received. If the caller’s phone number matches an entry in the call block list, the unit emits no sound to the caller, and disconnects the call. (Caller ID subscribers only)

- \*1 This is called first ring. If you do not want the first ring to sound, turn this setting to “**OFF**” (page 21).

#### Important:

- Blocked calls are logged in the caller list.

### Storing unwanted callers

You can store up to 30 phone numbers in the call block list.

#### Important:

- We recommend storing 10 digits (including the area code). If only 7 digits are stored, all numbers that have the same last 7 digits will be blocked.

#### ■ From the caller list:

- 1 **[▼]** CID
- 2 **[↕]**: Select the entry to be blocked.
  - To edit the number: **[MENU]** → **[↕]**: "Edit" → **[SELECT]**  
Press **[EDIT]** repeatedly until the phone number is shown in the 10-digit format. And then, press **[SAVE]**. Go to step 5.
- 3 **[MENU]**
- 4 **[↕]**: "Save CID" → **[SELECT]**
- 5 **[↕]**: "Call block" → **[SELECT]**
- 6 **[↕]**: "Yes" → **[SELECT]**
- 7 Edit the phone number if necessary (24 digits max.).
- 8 **[SAVE]** → **[OFF]**

#### ■ By entering phone numbers:

- 1 **[MENU]** **#** **2** **1** **7**
- 2 **[MENU]** → **[↕]**: "Add" → **[SELECT]**
- 3 Enter the phone number (24 digits max.).
  - To erase a digit, press **[CLEAR]**.
- 4 **[SAVE]** → **[OFF]**

### Blocking incoming calls that have no phone number

You can block calls when no phone number is provided, such as private callers or out of area calls.

- 1 **[MENU]** **#** **2** **4** **0**
- 2 **[↕]**: Select the desired setting. → **[SAVE]** → **[OFF]**

### Turning the first ring on and off

You can choose whether the first ring sounds when a call is received.

"On" (default): The first ring for all calls will be heard, including calls from blocked phone numbers.

"Off": The first ring is muted for all calls. If this setting is selected, the unit will never ring for calls from blocked phone numbers.

- 1 **[MENU]** **#** **1** **7** **3**
- 2 **[↕]**: Select the desired setting. → **[SAVE]** → **[OFF]**

### Viewing/editing/erasing call block numbers

- 1 **[MENU]** **#** **2** **1** **7**
- 2 **[↕]**: Select the desired entry.
- 3 **To edit a number:**  
**[EDIT]** → Edit the phone number. → **[SAVE]** → **[OFF]**  
**To erase a number:**  
**[ERASE]** → **[↕]**: "Yes" → **[SELECT]** → **[OFF]**

#### Note:

- When viewing, "Block w/o num" is displayed if the blocking incoming calls without phone number feature is turned on. To turn the feature off: **[ERASE]** → **[▼]** → **[SAVE]** → **[OFF]**

### Other programming

#### Changing the handset name

- 1 **[MENU]** **#** **1** **0** **4**
- 2 Enter the desired name.
- 3 **[SAVE]**
- 4 **[↕]**: Select the desired setting. → **[SELECT]** 2 times → **[OFF]**

## Programming

---

### Registering a handset to the base unit

If for some reason the handset is not registered to the base unit, re-register the handset.

- 1 Handset:**  
[MENU] [#] [1] [3] [0]
- 2 Base unit:**  
Press and hold [•••] for about 5 seconds.
  - If all registered handsets start ringing, press [•••] again to stop, then repeat this step.
- 3 Handset:**  
Press [OK], then wait until a long beep sounds.

---

### Deregistering a handset

- 1 [MENU] [#] [1] [3] [1]**
  - All handsets registered to the base unit are displayed.
- 2 [↕]:** Select the handset you want to cancel. → [SELECT]
- 3 [↕]:** "Yes" → [SELECT] → [OFF]

## Using Caller ID service

### Important:

- This unit is Caller ID compatible. To use Caller ID features, you must subscribe to a Caller ID service. Contact your phone service provider for details.

### Caller ID features

When an outside call is being received, the caller information is displayed.

Caller information for the last 50 callers is logged in the caller list from the most recent call to the oldest.

- If the unit cannot receive caller information, the following is displayed:
  - “**Out of area**”: The caller dials from an area which does not provide a Caller ID service.
  - “**Private caller**”: The caller requests not to send caller information.
  - “**Long distance**”: The caller makes a long distance call.
- If the unit is connected to a PBX system, caller information may not be properly received. Contact your PBX supplier.

## Caller list

### Viewing the caller list and calling back

- 1 [▼] CID
- 2 Press [▼] to search from the most recent call, or [▲] to search from the oldest call.
- 3 To call back, press [↶].

### Editing a caller's phone number

- 1 [▼] CID
- 2 [↕]: Select the desired entry.
- 3 [MENU] → [↕]: “Edit” → [SELECT]
- 4 Press [EDIT] repeatedly until the phone number is shown in the desired format.

## 5 [↶]

### Auto edit feature

After you edit and call back a phone number in the caller list, the unit remembers the way you edited the phone number and edits subsequent calls from the same area code in the same way.

#### Note:

- This feature can be set for each unit (page 19).

### Erasing selected caller information

- 1 [▼] CID
- 2 [↕]: Select the desired entry.
- 3 [ERASE] → [↕]: “Yes” → [SELECT] → [OFF]

## Answering System

### Answering system (KX-TGC360 series)

The answering system can answer calls and record caller messages. If you do not want to record messages, select “**Greeting only**” as the recording time setting (page 27).

#### Recording capacity

The total recording time is about 17 minutes, including your greeting message. Up to 64 messages can be recorded.

##### Note:

- When message memory becomes full:
  - “**Messages full**” is shown on the handset display.
  - The ANSWER ON/OFF indicator on the base unit flashes rapidly if the answering system is turned on.

### Turning the answering system on/off

#### Base unit

Press **[ANSWER ON/OFF]** to turn on/off the answering system.

### Greeting message

#### Recording your greeting message

- 1 **[MENU][#][3][0][2]**
- 2 **[↕]: “Yes” → [SELECT]**
- 3 After a beep sounds, hold the handset away and speak clearly into the microphone.
- 4 Press **[STOP]** to stop recording. → **[OFF]**

#### Using a pre-recorded greeting message

Select “**Greeting only**” in step 2 of “**Caller’s recording time**”, page 27.

#### Resetting to a pre-recorded greeting message

- 1 **[MENU][#][3][0][4]**
- 2 **[YES] → [OFF]**

#### Playing back the greeting message

- 1 **[MENU][#][3][0][3]**
- 2 To exit, press **[OFF]**.

### Listening to messages

#### Using the base unit

When new messages have been recorded, message indicator on the base unit flashes. Press **[▶■]** (PLAY).

- New messages will be played. If there are no new messages, old messages will be played.

#### Operating the answering system during playback

Key	Operation
<b>[+] or [-]</b>	Adjust the speaker volume
<b>[◀◀]</b>	Repeat message
<b>[▶▶]</b>	Skip message
<b>[▶■] (STOP)</b>	Stop playback
<b>[ERASE]</b>	Erase currently playing message



### Erasing all messages

Press **[ERASE]** 2 times while the unit is not in use.

### Using the handset

When new messages have been recorded, “**New message**” is displayed.

- 1 **To listen to new messages:**  
**[MENU]** **[#]** **[3]** **[2]** **[3]**  
**To listen to all messages:**  
**[MENU]** **[#]** **[3]** **[2]** **[4]**
- 2 When finished, press **[OFF]**.

### Operating the answering system

**[MENU]** → **[↕]**: “**Answering device**” → **[SELECT]**

Key	Operation
<b>[▲]</b> or <b>[▼]</b>	Adjust the receiver/speaker volume (during playback)
<b>[1]</b> or <b>[←]</b>	Repeat message (during playback)
<b>[2]</b> or <b>[→]</b>	Skip message (during playback)
<b>[3]</b>	Enter the “ <b>Settings</b> ” menu
<b>[4]</b>	Play new messages
<b>[5]</b>	Play all messages
<b>[6]</b>	Play greeting message
<b>[7]</b> <b>[6]</b>	Record greeting message
<b>[8]</b>	Turn answering system on
<b>[PAUSE]</b>	Pause message*1
<b>[9]</b> or <b>[STOP]</b>	Stop recording Stop playback
<b>[0]</b>	Turn answering system off
<b>[*]</b> <b>[4]</b>	Erase currently playing message
<b>[*]</b> <b>[5]</b>	Erase all messages
<b>[*]</b> <b>[6]</b>	Reset to a pre-recorded greeting message

\*1 To resume playback:  
**[↕]**: “**Playback**” → **[SELECT]**

### Calling back (Caller ID subscribers only)

- 1 Press **[PAUSE]** during playback.
- 2 **[↕]**: “**Call back**” → **[SELECT]**

### Remote operation

You can use a touch-tone phone to call the unit while away from home and listen to messages.

### Remote access code

For security, a 3-digit remote access code must be entered when operating the answering system remotely. The default setting is “111”.

#### Important:

- To prevent unauthorized access to this product, we recommend that you regularly change the remote code.

- 1 **[MENU]** **[#]** **[3]** **[0]** **[6]**
- 2 Enter the desired 3-digit remote access code.
  - To deactivate remote operation, press **[\*]**.
- 3 **[SAVE]** → **[OFF]**

### Using the answering system remotely

- 1 Dial your phone number from a touch-tone phone.
- 2 After the greeting message starts, enter your remote access code.
- 3 Follow the voice guidance prompts as necessary or control the unit using remote commands (page 26).
- 4 When finished, hang up.

## Answering System

### Voice guidance

#### ■ When the English voice guidance is selected

During remote operation, the unit's voice guidance starts and prompts you to press **[1]** to perform a specific operation, or press **[2]** to listen to more available operations.

#### ■ When the Spanish voice guidance is selected

To start the voice guidance, press **[9]**. The voice guidance announces the available remote commands (page 26).

#### Note:

- If you do not press any dial keys within 10 seconds after a voice guidance prompt, the unit disconnects your call.

### Remote commands

Key	Operation
<b>[1]</b>	Repeat message (during playback)
<b>[2]</b>	Skip message (during playback)
<b>[4]</b>	Play new messages
<b>[5]</b>	Play all messages
<b>[9]</b>	Stop playback* <sup>1</sup> Start voice guidance* <sup>2</sup>
<b>[0]</b>	Turn answering system off
<b>[*][4]</b>	Erase currently playing message
<b>[*][5]</b>	Erase all messages
<b>[*][#]</b>	End remote operation (or hang up)

\*1 For English voice guidance only

\*2 For Spanish voice guidance only

### Turning on the answering system remotely

- 1 Dial your phone number from a touch-tone phone.
- 2 Let the phone ring 15 times.
  - A long beep is heard.
- 3 Enter your remote access code within 10 seconds after the long beep.
  - The greeting message is played back.
  - You can either hang up, or enter your remote access code again and begin remote operation (page 25).

## Answering system settings

### Call screening

While a caller is leaving a message, you can listen to the call through the handset's speaker.

- 1 **[MENU][#][3][1][0]**
- 2 **[↕]**: Select the desired setting. → **[SAVE]** → **[OFF]**

### Number of rings before the unit answers a call

You can change the number of times the phone rings "Ring count" before the unit answers calls. You can select 2 to 7 rings, or "Toll saver".

The default setting is "4 rings".

"Toll saver": The unit's answering system answers at the end of the 2nd ring when new messages have been recorded, or at the end of the 5th ring when there are no new messages.

- 1 **[MENU][#][2][1][1]**
- 2 **[↕]**: Select the desired setting. → **[SAVE]** → **[OFF]**

### Caller's recording time

You can change the maximum message recording time allowed for each caller.

- 1 **[MENU]** **#** **3** **0** **5**
- 2 **[↓]**: Select the desired setting. →  
**[SAVE]** → **[OFF]**

### Selecting "Greeting only"

You can select "Greeting only" which sets the unit to announce a greeting message to callers but not record messages.

Select "Greeting only" in step 2 on "Caller's recording time", page 27.

## Useful Information

### Voice mail service

In addition to your unit's answering system you may also have voicemail service from your phone service provider. Voicemail is an answering service that may be offered by your phone service provider. This service can also record calls when you are unavailable to answer the phone or when your line is busy. Messages are recorded on the phone company system and not on the unit's answering system.

- To use the voicemail service rather than the unit's answering system, turn off the answering system (page 24).

If you have unit's answering system set to on and also the voicemail enabled, the system with least amount of rings will record the message first.

#### Example:

If the unit's answering system is set to 4 rings (page 26) and the voicemail answering system provided by your phone company is set to 6 rings (call your service provider), the unit's answering system will record the incoming call first.

### Storing the voicemail (VM) access number

You can store the phone number used to access your voicemail service.

- 1 **[MENU]#331**
- 2 Enter your access number. → **[SAVE]** → **[OFF]**

#### Note:

- When storing your voicemail access number and your mailbox password, press **[▲]** (Pause) to add pauses (page 12) between the access number and the password as necessary. Contact your phone service provider for the required pause time.

#### Example:

1-222-333-4444	PPPP	8888
VM access number	Pauses	Password

### To erase the voicemail access number

- 1 **[MENU]#331**
- 2 Press and hold **[CLEAR]** until all digits are erased. → **[SAVE]** → **[OFF]**

### Voice mail (VM) tone detection

Your voicemail service provider sends special signals to the unit to let you know that you have new voicemail messages. If you hear a series of dial tones followed by a continuous dial tone after you press **[↶]**, you have new voicemail messages.

The unit can detect these signals automatically. Turn this feature off in the following situations.

- You do not subscribe to voicemail service.
- Your phone is connected to a PBX.

### Turning VM tone detection on/off

- 1 **[MENU]#332**
- 2 **[↕]**: Select the desired setting. → **[SAVE]** → **[OFF]**

### Listening to voicemail messages

- 1 **[MENU]#330**
  - The speakerphone turns on.
- 2 Follow the pre-recorded instructions.
- 3 When finished, press **[OFF]**.

#### Note:

- You can also use the **[VM]** soft key, if displayed, to play new voicemail messages.
- If the handset still indicate there are new messages even after you have listened to all new messages, turn it off by pressing and holding **[#]** until the handset beeps.

## Error messages

Display message	Cause/solution
Base no power or No link. Re-connect base AC adaptor.	<ul style="list-style-type: none"> <li>● The handset has lost communication with the base unit. Move closer to the base unit and try again.</li> <li>● Unplug the base unit's AC adaptor to reset the unit. Reconnect the adaptor and try again.</li> <li>● The handset's registration may have been canceled. Re-register the handset (page 22).</li> </ul>
Busy	<ul style="list-style-type: none"> <li>● Other units are in use and the system is busy. Try again later.</li> </ul>
Call phone company for your access #	<ul style="list-style-type: none"> <li>● You have not stored the voicemail access number. Store the number (page 28).</li> </ul>
Check tel line	<ul style="list-style-type: none"> <li>● The supplied telephone line cord has not been connected yet or not connected properly. Check the connections (page 8).</li> </ul>
Error!!	<ul style="list-style-type: none"> <li>● Recording was too short. Try again.</li> </ul>
Invalid	<ul style="list-style-type: none"> <li>● There is no handset registered to the base unit matching the handset number you entered.</li> <li>● The handset is not registered to the base unit. Register the handset (page 22).</li> </ul>
Use rechargeable battery.	<ul style="list-style-type: none"> <li>● A wrong type of battery such as alkaline or manganese was inserted. Use only the rechargeable Ni-MH batteries noted on page 4, 6.</li> </ul>

## Troubleshooting

If you still have difficulties after following the instructions in this section, disconnect the base unit's AC adaptor, then reconnect the base unit's AC adaptor. Remove the batteries from the handset, and then insert the batteries into the handset again.



### General use

Problem	Cause/solution
The handset does not turn on even after installing charged batteries.	<ul style="list-style-type: none"> <li>● Place the handset on the base unit or charger to turn on the handset.</li> </ul>
The unit does not work.	<ul style="list-style-type: none"> <li>● Make sure the batteries are installed correctly (page 8).</li> <li>● Fully charge the batteries (page 8).</li> <li>● Check the connections (page 8).</li> <li>● Unplug the base unit's AC adaptor to reset the unit. Reconnect the adaptor and try again.</li> <li>● The handset has not been registered to the base unit. Register the handset (page 22).</li> </ul>

## Useful Information

Problem	Cause/solution
I cannot hear a dial tone.	<ul style="list-style-type: none"><li>• The base unit's AC adaptor or telephone line cord is not connected. Check the connections.</li></ul>
Time on the unit has shifted.	<ul style="list-style-type: none"><li>• Incorrect time information from incoming Caller ID changes the time. Set the time adjustment to "Manual" (off) (page 18).</li></ul>

## Battery recharge

Problem	Cause/solution
I fully charged the batteries, but –  still flashes, –  is displayed, or – the operating time seems to be shorter.	<ul style="list-style-type: none"><li>• Clean the battery ends (+, -) and the charge contacts with a dry cloth and charge again.</li><li>• It is time to replace the batteries (page 8).</li></ul>

## Making/answering calls, intercom

Problem	Cause/solution
 is displayed.	<ul style="list-style-type: none"><li>• The handset is too far from the base unit. Move closer.</li><li>• The base unit's AC adaptor is not properly connected. Reconnect AC adaptor to the base unit.</li><li>• The handset is not registered to the base unit. Register it (page 22).</li></ul>
Noise is heard, sound cuts in and out.	<ul style="list-style-type: none"><li>• You are using the handset or base unit in an area with high electrical interference. Re-position the base unit and use the handset away from sources of interference.</li><li>• Move closer to the base unit.</li><li>• If you use a DSL/ADSL service, we recommend connecting a DSL/ADSL filter between the base unit and the telephone line jack. Contact your DSL/ADSL provider for details.</li></ul>
The handset does not ring.	<ul style="list-style-type: none"><li>• The ringer volume is turned off. Adjust the ringer volume (page 12, 18).</li><li>• Silent mode is turned on. Turn it off (page 20).</li></ul>
I cannot make a call.	<ul style="list-style-type: none"><li>• The dialing mode may be set incorrectly. Change the setting (page 11).</li></ul>

## Useful Information

### Caller ID

Problem	Cause/solution
Caller information is not displayed.	<ul style="list-style-type: none"><li>• You must subscribe to Caller ID service. Contact your phone service provider for details.</li><li>• If your unit is connected to any additional telephone equipment such as a Caller ID box or cordless telephone line jack, plug the unit directly into the wall jack.</li><li>• If you use a DSL/ADSL service, we recommend connecting a DSL/ADSL filter between the base unit and the telephone line jack. Contact your DSL/ADSL provider for details.</li><li>• The name display service may not be available in some areas. Contact your phone service provider for details.</li></ul>
Caller information is displayed late.	<ul style="list-style-type: none"><li>• Depending on your phone service provider, the unit may display the caller's information at the 2nd ring or later.</li></ul>

### Answering system

Problem	Cause/solution
The unit does not record new messages.	<ul style="list-style-type: none"><li>• The answering system is turned off. Turn it on (page 24).</li><li>• The message memory is full. Erase unnecessary messages (page 24).</li><li>• The recording time is set to "Greeting only". Change the setting (page 27).</li><li>• Your phone service provider's voicemail service may be answering your calls before the unit's answering system can answer your calls. Change the unit's number of rings setting (page 26) to a lower value, or contact your phone service provider.</li></ul>

### Voicemail

Problem	Cause/solution
"New Voice Mail" is shown on the handset display. How do I remove this message from the display?	<ul style="list-style-type: none"><li>• Listen your new voicemail messages (page 28). Depending on your voicemail service provider, you may need to erase all messages in your voice mailbox in order to remove this message.</li><li>• You can remove this message manually by pressing and holding <b>#</b> until the unit beeps.</li></ul>

## Useful Information

### Liquid damage

Problem	Cause/solution
Liquid or other form of moisture has entered the handset/base unit.	<ul style="list-style-type: none"><li>• Disconnect the AC adaptor and telephone line cord from the base unit. Remove the batteries from the handset and leave to dry for at least 3 days. After the handset/base unit are completely dry, reconnect the AC adaptor and telephone line cord. Insert the batteries and charge fully before use. If the unit does not work properly, contact an authorized service center.</li></ul>

#### Caution:

- To avoid permanent damage, do not use a microwave oven to speed up the drying process.

### Wall mounting (Charger only)

#### Note:

- Make sure that the wall and the fixing method are strong enough to support the weight of the unit.

Drive the screws (A) (not supplied) into the wall.

(B) 27.2 mm (1 1/16 inches)

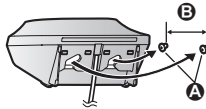



## FCC and other information

This equipment complies with Part 68 of the FCC rules and the requirements adopted by the ACTA. On the bottom of this equipment is a label that contains, among other information, a product identifier in the format US:ACJ-----.

If requested, this number must be provided to the telephone company.

- Registration No:
  - KX-TGC350 series: found the rear of the unit
  - KX-TGC360 series: found the bottom of the unit
- Ringer Equivalence No. (REN).....0.1B

A plug and jack used to connect this equipment to the premises wiring and telephone network must comply with the applicable FCC Part 68 rules and requirements adopted by the ACTA. A compliant telephone cord and modular plug is provided with the product. It is designed to be connected to a compatible modular jack that is also compliant.

The REN is used to determine the number of devices that may be connected to a telephone line. Excessive RENs on a telephone line may result in the devices not ringing in response to an incoming call. In most but not all areas, the sum of RENs should not exceed five (5.0). To be certain of the number of devices that may be connected to a line, as determined by the total RENs, contact the local telephone company. For products approved after July 23, 2001, the REN for the product is part of the product identifier that has the format US:AAAEQ##TXXXX. The digits represented by ## are the REN without a decimal point (e.g., 03 is a REN of 0.3).

If this equipment causes harm to the telephone network, the telephone company will notify you in advance that temporary discontinuance of service may be required.

But if advance notice isn't practical, the telephone company will notify the customer as soon as possible. Also, you will be advised of your right to file a complaint with the FCC if you believe it is necessary.

The telephone company may make changes in its facilities, equipment, operations or procedures that could affect the operation of the equipment. If this happens the telephone company will provide advance notice in order for you to make necessary modifications to maintain uninterrupted service.

If trouble is experienced with this equipment, for repair or warranty information, please contact a Factory Service Center or other Authorized Servicer. If the equipment is causing harm to the telephone network, the telephone company may request that you disconnect the equipment until the problem is resolved.

Connection to party line service is subject to state tariffs. Contact the state public utility commission, public service commission or corporation commission for information.

If your home has specially wired alarm equipment connected to the telephone line, ensure the installation of this equipment does not disable your alarm equipment. If you have questions about what will disable alarm equipment, consult your telephone company or a qualified installer.

This equipment is hearing aid compatible as defined by the FCC in 47 CFR Section 68.316.

When you hold the phone to your ear, noise might be heard in your Hearing Aid. Some Hearing Aids are not adequately shielded from external RF (radio frequency) energy. If noise occurs, use an optional headset

## Useful Information

accessory or the speakerphone option (if applicable) when using this phone. Consult with your audiologist or Hearing Aid manufacturer about the availability of Hearing Aids which provide adequate shielding to RF energy commonly emitted by digital devices.

### WHEN PROGRAMMING EMERGENCY NUMBERS AND/OR MAKING TEST CALLS TO EMERGENCY NUMBERS:

- 1) Remain on the line and briefly explain to the dispatcher the reason for the call.
- 2) Perform such activities in the off-peak hours, such as early morning or late evenings.

This device complies with Part 15 of the FCC Rules. Operation is subject to the following two conditions:

(1) This device may not cause harmful interference, and (2) this device must accept any interference received, including interference that may cause undesired operation.

Privacy of communications may not be ensured when using this phone.

### CAUTION:

Any changes or modifications not expressly approved by the party responsible for compliance could void the user's authority to operate this device.

### NOTE:

This equipment has been tested and found to comply with the limits for a Class B digital device, pursuant to Part 15 of the FCC Rules. These limits are designed to provide reasonable protection against harmful interference in a residential installation. This equipment generates, uses, and can radiate radio frequency energy and, if not installed and used in accordance with the instructions, may cause harmful interference to radio communications.

However, there is no guarantee that interference will not occur in a particular

installation. If this equipment does cause harmful interference to radio or television reception, which can be determined by turning the equipment off and on, the user is encouraged to try to correct the interference by one or more of the following measures:

- Reorient or relocate the receiving antenna.
- Increase the separation between the equipment and receiver.
- Connect the equipment into an outlet on a circuit different from that to which the receiver is connected.
- Consult the dealer or an experienced radio/TV technician for help.

Some cordless telephones operate at frequencies that may cause interference to nearby TVs and VCRs. To minimize or prevent such interference, the base of the cordless telephone should not be placed near or on top of a TV or VCR. If interference is experienced, move the cordless telephone further away from the TV or VCR. This will often reduce or eliminate interference.

### FCC RF Exposure Warning:

- This product complies with FCC radiation exposure limits set forth for an uncontrolled environment.
- To comply with FCC RF exposure requirements, the base unit must be installed and operated 20 cm (8 inches) or more between the product and all person's body.
- This product may not be collocated or operated in conjunction with any other antenna or transmitter.
- For body-worn operation, the handset must be used only with a non-metallic accessory. Use of other accessories may not ensure compliance with FCC RF exposure requirements.

### Notice:

- FCC ID can be found inside the battery compartment or on the bottom of the units.

## Useful Information

### Compliance with TIA-1083 standard:

Telephone handsets identified with this logo have reduced noise and interference when used with T-Coil equipped hearing aids and cochlear implants.

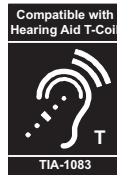

## Guía Rápida Española

### Conexiones

- ① Conecte el adaptador de corriente alterna a la unidad presionándolo firmemente.
- ② Enganche el cable para fijarlo.
- ③ Conecte el adaptador de corriente alterna a la toma de corriente.
- ④ Conecte el cable de la línea telefónica a la unidad, y después a la toma telefónica de una sola línea (RJ11C) hasta que escuche un clic.
- ⑤ Se requiere un filtro DSL/ADSL (no incluido) si tiene este tipo de servicio.

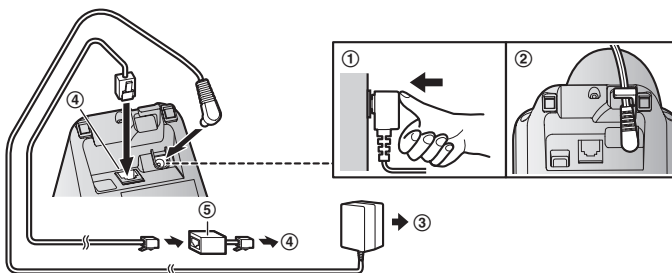

### Instalación y carga de la batería

Cargue aproximadamente durante 7 horas.

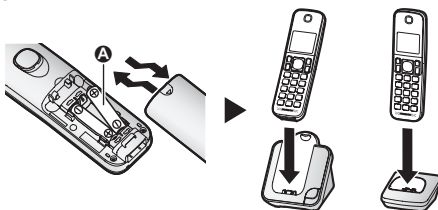

**Nota:**

- UTILICE SOLO baterías recargables de Ni-MH tamaño AAA (R03) (A).
- NO utilice baterías alcalinas, de manganeso o de Ni-Cd.
- Confirme que las polaridades estén correctas (⊕, ⊖).
- Cambie el idioma de la pantalla.

**Sugerencias de operación**

**Teclas de función**

Al oprimir una tecla de función, puede seleccionar la función que aparece directamente encima de ella en la pantalla. Preste atención a la pantalla para ver qué funciones están asignadas a las teclas de función durante la operación.

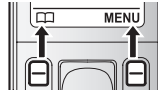

**Tecla navegadora**

- [▲], [▼], [◀] o [▶]: Navegue por diversas listas y elementos.
- VOL. (Volumen: [▲] o [▼]): Ajuste el volumen del receptor o el altavoz mientras habla.
- [◀] □ □: Vea la entrada del directorio telefónico.
- [▼] CID (identificador de llamadas): Vea la lista de personas que llamaron.
- [▶] REDIAL (Remarcación): Vea la lista de remarcación.

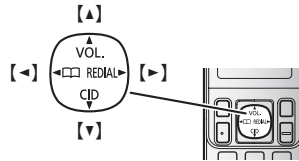

**Cambio de idiomas (Auricular) (predeterminado: "English")**

Cuando instale las baterías por primera vez, es posible que aparezca "Date and time Press SELECT". Oprima [OFF] para salir.

**Idioma de la pantalla**

[MENU] # 1 1 0 → [↕]: "Español" → [GUARDA] → [OFF]

**Idioma de la guía de voz**

Disponible para: serie KX-TGC360

[MENU] # 1 1 2 → [↕]: "Español" → [GUARDA] → [OFF]

**Fecha y hora (Auricular)**

- 1 [MENU] # 1 0 1
- 2 Introduzca el día, mes y año actuales. → [OK]
- 3 Introduzca la hora y minuto actuales (formato de reloj de 24 horas).
- 4 [GUARDA] → [OFF]

## Guía Rápida Española

### Operaciones básicas

#### Cómo hacer y contestar llamadas (Auricular)

Para hacer llamadas	Marque el número telefónico. → [📞]/[📞]
Para contestar llamadas	[📞]/[📞]
Para colgar	[OFF]
Para ajustar el volumen del receptor o del altavoz	Oprima [▲] o [▼] repetidamente mientras habla.
Cómo hacer una llamada usando la lista de remarcación	[▶] REDIAL → [⏮]: Seleccione la entrada deseada. → [📞]
Para ajustar el volumen del timbre del auricular	Oprima [▲] o [▼] repetidamente mientras timbra.

#### Directorio telefónico (Auricular)

Para añadir entradas	<ol style="list-style-type: none"> <li>1 [□□] o [◀] □□ → [MENU]</li> <li>2 [⏮]: "Agregar Ent. Nueva" → [SELEC.]</li> <li>3 Introduzca el nombre de la persona (máx. 16 caracteres). → [OK]</li> <li>4 Introduzca el número telefónico de la persona (máx. 24 dígitos). → [OK]</li> <li>5 [⏮]: Seleccione el grupo deseado. → [SELEC.] 2 veces → [OFF]</li> </ol>
Para hacer llamadas	<ol style="list-style-type: none"> <li>1 [□□] o [◀] □□</li> <li>2 [⏮]: Seleccione la entrada deseada. → [📞]</li> </ol>

#### Sistema contestador de llamadas (unidad base: serie KX-TGC360)

Contestador encendido/apagado	Oprima [ANSWER ON/OFF] para encender y apagar el contestador de llamadas.
Para escuchar mensajes	[▶■] (PLAY)

#### Sistema contestador de llamadas (auricular: serie KX-TGC360)

Para escuchar mensajes	<p>Para escuchar mensajes nuevos: [REPRO.] o [MENU] #]3]2]3]</p> <p>Para escuchar todos los mensajes: [MENU] #]3]2]4]</p>
------------------------	-----------------------------------------------------------------------------------------------------------------------------------

**Preguntas frecuentes**

Pregunta	Causa y solución
¿Por qué aparece  ?	<ul style="list-style-type: none"> <li>• El auricular está demasiado lejos de la unidad base. Acérquelo.</li> <li>• El adaptador para corriente de la unidad base no está conectado correctamente. Conecte de nuevo el adaptador para corriente a la unidad base.</li> <li>• El auricular no está registrado en la unidad base. Regístrelo. <ol style="list-style-type: none"> <li><b>1 Auricular:</b> <b>[MENU]</b> <b>[#]</b> <b>[1]</b> <b>[3]</b> <b>[0]</b></li> <li><b>2 Unidad base:</b> Oprima y mantenga oprimido <b>[••]</b> durante aproximadamente 5 segundos.</li> <li><b>3 Auricular:</b> Oprima <b>[OK]</b>, y después espere hasta que suene un pitido largo.</li> </ol> </li> </ul>
¿Cómo se incrementa el nivel de volumen del auricular?	<ul style="list-style-type: none"> <li>• Oprima la tecla de navegación <b>[▲]</b> repetidamente mientras habla.</li> </ul>
¿Por qué hay ruido o se corta la conversación?	<ul style="list-style-type: none"> <li>• Trate de reubicar la unidad base de forma que se minimice la distancia al auricular.</li> <li>• Si ocurre el mismo problema aunque el auricular se encuentre enseguida de la unidad base, visite <a href="http://shop.panasonic.com/support">http://shop.panasonic.com/support</a></li> </ul>
¿Es posible añadir otro auricular accesorio a mi unidad base?	<ul style="list-style-type: none"> <li>• Sí, puede añadir hasta 6 auriculares (incluyendo los que se venden con su unidad base) a una sola unidad base.</li> <li>• Para adquirir auriculares accesorios adicionales (KX-TGDA20), visite: <a href="http://shop.panasonic.com/support">http://shop.panasonic.com/support</a></li> </ul> <p>Los usuarios TTY (usuarios con impedimentos auditivos o del habla) pueden llamar al 1-877-833-8855.</p>
¿Es posible mantener cargando las baterías todo el tiempo?	<ul style="list-style-type: none"> <li>• Puede dejar el auricular en la unidad base o el cargador en cualquier momento. Esto no daña las baterías.</li> </ul>
¿Cómo se contestan las llamadas en espera (2ª llamada)?	<ul style="list-style-type: none"> <li>• Oprima <b>[CALL WAIT]</b> cuando escuche el tono de llamada en espera.</li> </ul>

Customer services

**Shop**  
**Accessories!**

for all your Panasonic gear

Go to

<http://shop.panasonic.com/support>

Get everything you need to get the most out of  
your Panasonic products

Accessories & Parts for your Camera, Phone, A/V  
products, TV, Computers & Networking, Personal  
Care, Home Appliances, Headphones, Batteries,  
Backup Chargers & more...

**Customer Services Directory**

For Product Information, Operating Assistance,  
Parts, Owner's Manuals, Dealer and Service info  
go to <http://shop.panasonic.com/support>

For the hearing or speech impaired TTY: 1- 877-833-8855

As of June 2015



## Limited Warranty (ONLY FOR U.S.A.)

# Panasonic Products Limited Warranty

### Limited Warranty Coverage (For USA Only)

If your product does not work properly because of a defect in materials or workmanship, Panasonic Corporation of North America (referred to as "the warrantor") will, for the length of the period indicated on the chart below, which starts with the date of original purchase ("warranty period"), at its option either (a) repair your product with new or refurbished parts, (b) replace it with a new or a refurbished equivalent value product, or (c) refund your purchase price. The decision to repair, replace or refund will be made by the warrantor.

Product or Part Name	Parts	Labor
Telephone	One (1) Year	One (1) Year

During the "Labor" warranty period there will be no charge for labor. During the "Parts" warranty period, there will be no charge for parts. This Limited Warranty excludes both parts and labor for non-rechargeable batteries, antennas, and cosmetic parts (cabinet). This warranty only applies to products purchased and serviced in the United States. This warranty is extended only to the original purchaser of a new product which was not sold "as is".

**Mail-In Service**--Online Repair Request

### Online Repair Request

To submit a new repair request and for quick repair status visit our Web Site at <http://shop.panasonic.com/support>

When shipping the unit, carefully pack, include all supplied accessories listed in the Owner's Manual, and send it prepaid, adequately insured and packed well in a carton box. When shipping Lithium Ion batteries please visit our Web Site at <http://shop.panasonic.com/support> as Panasonic is committed to providing the most up to date information. Include a letter detailing the complaint, a return address and provide a daytime phone number where you can be reached. A valid registered receipt is required under the Limited Warranty.

**IF REPAIR IS NEEDED DURING THE WARRANTY PERIOD, THE PURCHASER WILL BE REQUIRED TO FURNISH A SALES RECEIPT/PROOF OF PURCHASE INDICATING DATE OF PURCHASE, AMOUNT PAID AND PLACE OF PURCHASE. CUSTOMER WILL BE CHARGED FOR THE REPAIR OF ANY UNIT RECEIVED WITHOUT SUCH PROOF OF PURCHASE.**

## Appendix

---

### **Limited Warranty Limits and Exclusions**

This warranty **ONLY COVERS** failures due to defects in materials or workmanship, and **DOES NOT COVER** normal wear and tear or cosmetic damage. The warranty **ALSO DOES NOT COVER** damages which occurred in shipment, or failures which are caused by products not supplied by the warrantor, or failures which result from accidents, misuse, abuse, neglect, mishandling, misapplication, alteration, faulty installation, set-up adjustments, misadjustment of consumer controls, improper maintenance, power line surge, lightning damage, modification, introduction of sand, humidity or liquids, commercial use such as hotel, office, restaurant, or other business or rental use of the product, or service by anyone other than a Factory Service Center or other Authorized Servicer, or damage that is attributable to acts of God.

**THERE ARE NO EXPRESS WARRANTIES EXCEPT AS LISTED UNDER "LIMITED WARRANTY COVERAGE".**

**THE WARRANTOR IS NOT LIABLE FOR INCIDENTAL OR CONSEQUENTIAL DAMAGES RESULTING FROM THE USE OF THIS PRODUCT, OR ARISING OUT OF ANY BREACH OF THIS WARRANTY.**

(As examples, this excludes damages for lost time, travel to and from the servicer, loss of or damage to media or images, data or other memory or recorded content. The items listed are not exclusive, but for illustration only.)

**ALL EXPRESS AND IMPLIED WARRANTIES, INCLUDING THE WARRANTY OF MERCHANTABILITY, ARE LIMITED TO THE PERIOD OF THE LIMITED WARRANTY.**

Some states do not allow the exclusion or limitation of incidental or consequential damages, or limitations on how long an implied warranty lasts, so the exclusions may not apply to you. This warranty gives you specific legal rights and you may also have other rights which vary from state to state. If a problem with this product develops during or after the warranty period, you may contact your dealer or Service Center. If the problem is not handled to your satisfaction, then write to:

Consumer Affairs Department  
Panasonic Corporation of North America  
661 Independence Pkwy  
Chesapeake, VA 23320

**PARTS AND SERVICE, WHICH ARE NOT COVERED BY THIS LIMITED WARRANTY, ARE YOUR RESPONSIBILITY.**

As of June 2015

**Index**

- A** Additional handset: 4
  - Alarm: 20
  - Answering calls: 12
  - Answering system
    - Call screening: 26
    - Erasing messages: 24, 25, 26
    - Greeting message: 24
    - Greeting only: 27
    - Listening to messages: 24, 25
    - Number of rings: 26
    - Recording time: 27
    - Remote access code: 25
    - Remote operation: 25
    - Ring count: 26
    - Toll saver: 26
    - Turning on/off: 24
  - Auto talk: 12, 19
- B** Battery: 8
  - Booster (Clarity booster): 10
- C** Call block: 20
  - First ring: 21
  - Call share: 13, 19
  - Call waiting: 12
  - Call Waiting Caller ID: 12
  - Caller ID number auto edit: 19, 23
  - Caller ID service: 23
  - Caller list: 23
  - Caller list edit: 23
  - Chain dial: 15
  - CID (Caller ID): 23
  - Conference calls: 13
  - Customer support: 19
- D** Date and time: 10
  - Dialing mode: 11
  - Direct command code: 17
  - Display
    - Contrast: 19
    - Language: 10
- E** Eco mode: 9
  - Error messages: 29
- F** Flash: 12, 19
- G** Groups: 14
- H** Handset
  - Deregistration: 22
  - Name: 21
  - Registration: 22
  - Hold: 12
- I** Intercom: 13
- K** Key tone: 19
- L** Line mode: 19
- M** Making calls: 12
  - Mute: 12
- P** Pause: 12
  - Phonebook: 14
- R** Redialing: 12
  - Ringer ID: 14
  - Ringer tone: 18
  - Rotary/pulse service: 13
- S** Silent mode: 20
  - Speed dial: 15
  - SP-PHONE (Speakerphone): 12
- T** Temporary tone dialing: 13
  - Time adjustment: 18
  - Transferring calls: 13
  - Troubleshooting: 29
  - TTY: 40
- V** VM (Voicemail): 28
  - Voice guidance language: 10
  - Voicemail: 28
  - Volume
    - Receiver: 12
    - Ringer (Base unit): 12
    - Ringer (Handset): 12, 18
    - Speaker: 12
- W** Wall mounting: 32

# IMPORTANT!

If your product is not working properly. . .

- ① **Reconnect AC adaptor to the base unit.**
- ② **Check if telephone line cord is connected.**
- ③ **Use rechargeable Ni-MH batteries.**  
(Alkaline/Manganese/Ni-Cd batteries CANNOT be used.)
- ④ Read **troubleshooting** page in the **Operating Instructions**.



Visit our Web site: <http://shop.panasonic.com/support>

- **FAQ and troubleshooting hints are available.**

#### For your future reference

We recommend keeping a record of the following information to assist with any repair under warranty.

Serial No.	Date of purchase
(found on the bottom of the base unit)	
Name and address of dealer	
Attach your purchase receipt here.	

Panasonic Corporation of North America

Two Riverfront Plaza, Newark, NJ 07102-5490

© Panasonic Corporation 2015

Printed in Malaysia



\*PNQX7789XA\*

**PNQX7789XA** PT1215MU2038